

uitwerkbijlage

Naam kandidaat _____ Kandidaatnummer _____

14

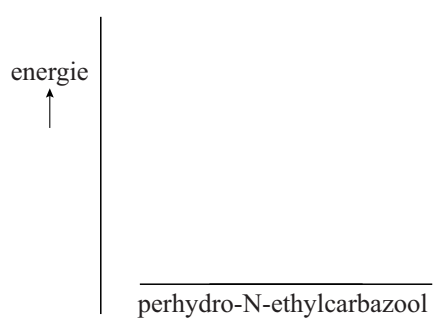

15

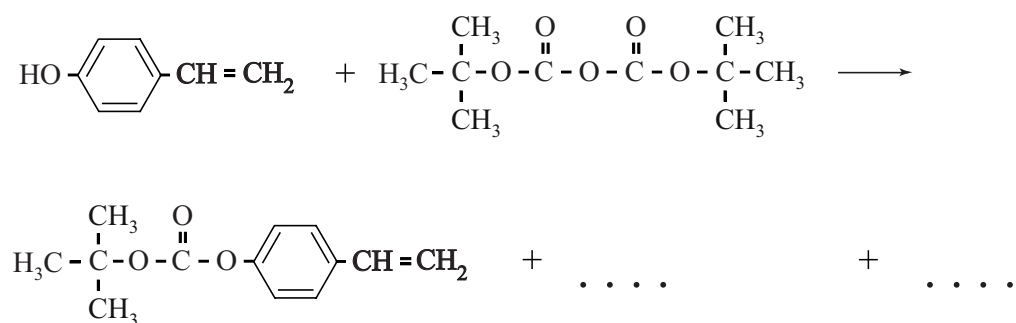

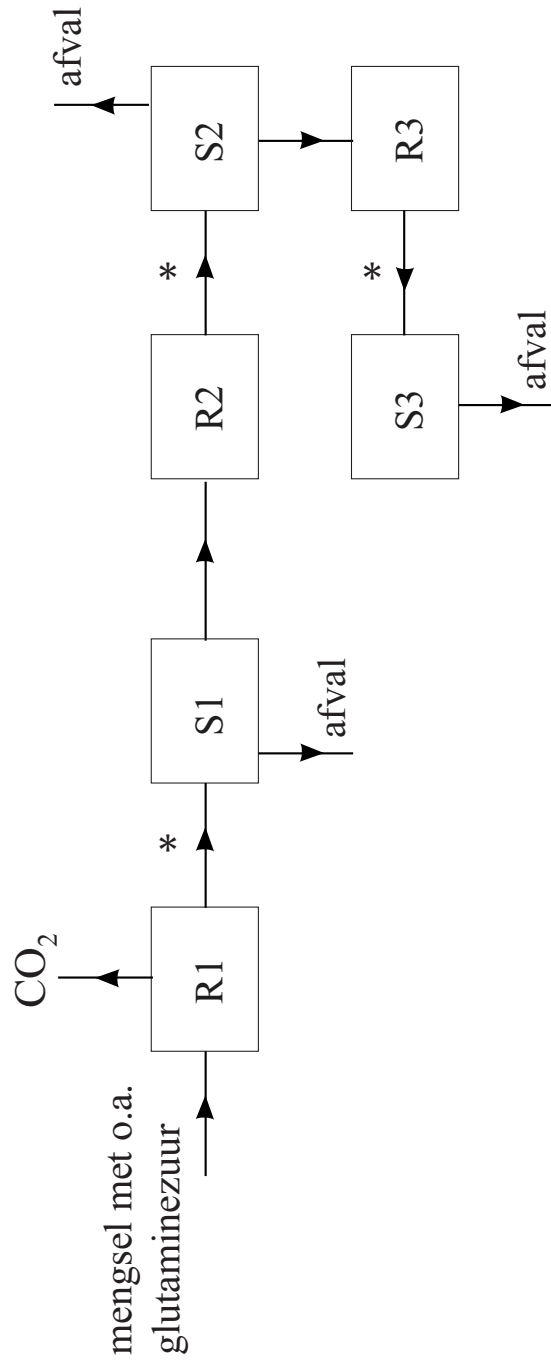

VERGEET NIET DEZE UITWERKBIJLAGE IN TE LEVEREN